

- ⒸZ Návod k instalaci a k použití
- Ⓔ Instrucciones de montaje y de manejo
- Ⓕ Instructions de montage et mode d'emploi
- ⒼB Installation and operating instructions
- Ⓕ Szerelési és használati utasítás
- Ⓘ Istruzioni di montaggio e per l'uso
- ⒼNL Montagehandleiding en Gebruiksaanwijzing
- ⒼNO Monterings- og bruksanvisning
- ⒼPL Instrukcja montażu i obsługi
- ⒼRU Руководство по монтажу и эксплуатации
- ⒼSK Návod na montáž a obsluhu

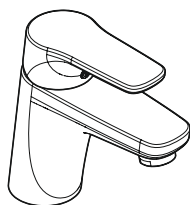

DEXSO

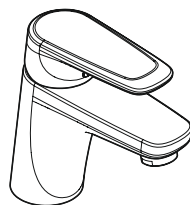

DESXSO

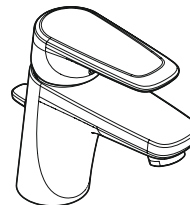

DESXS

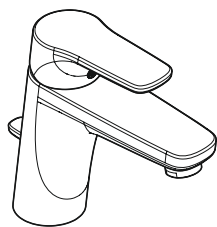

DE

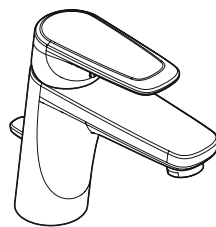

DES

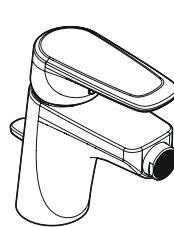

DESBD

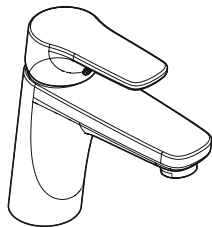

DEO

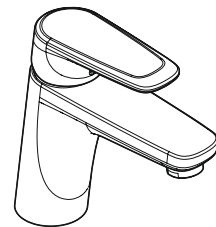

DESO

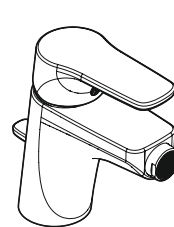

DEBD

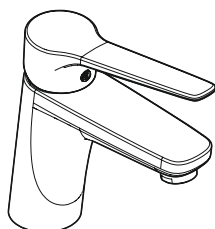

DEPGHO

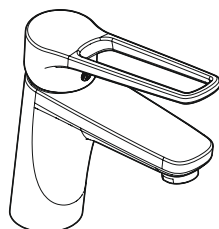

DEPOHO

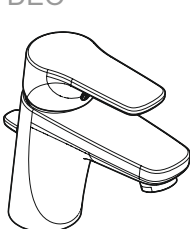

DEXS

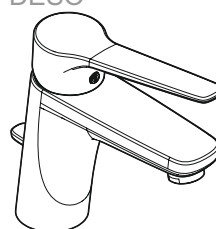

DEPGH

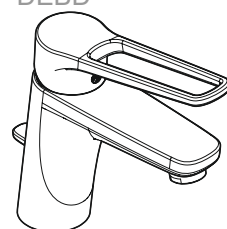

DEPOH

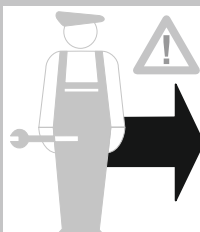

**DIN EN 806**  
**DIN EN 1717**  
**DIN 1988**  
**Global Standards**

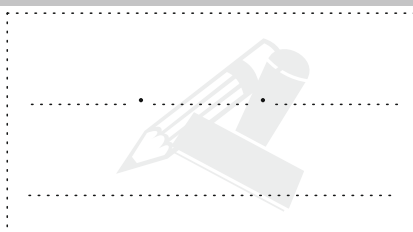



**VIGOUR** Water and Sanitation

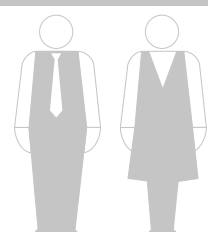

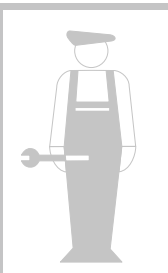

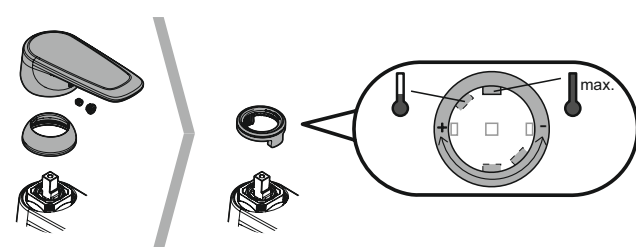

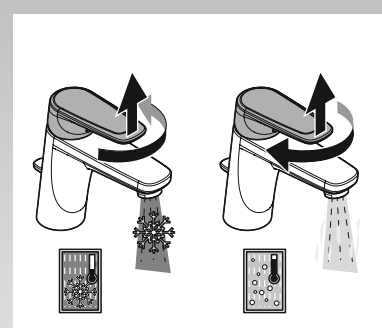

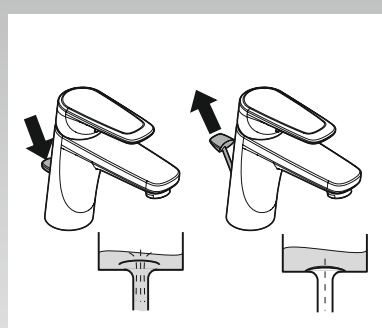

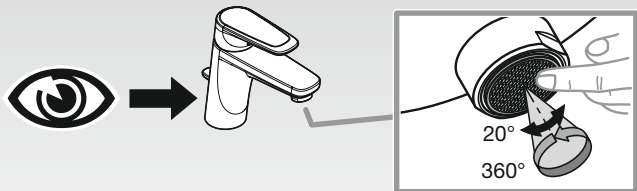



max. 70 °C / 158 °F  
min. 60 °C / 140 °F

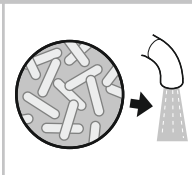

max. 70 °C / 158 °F

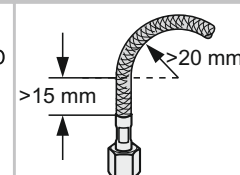
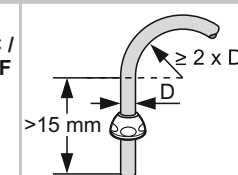

**1.**

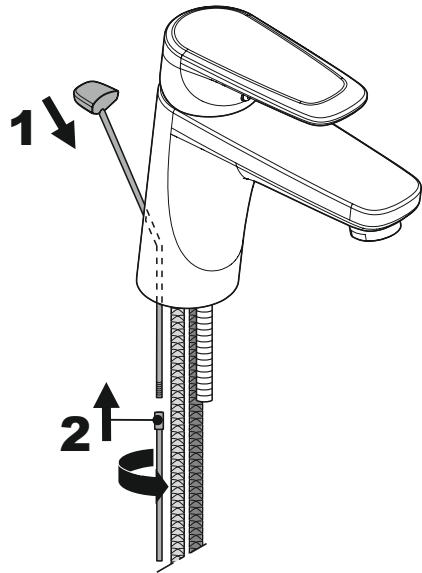

**2.**

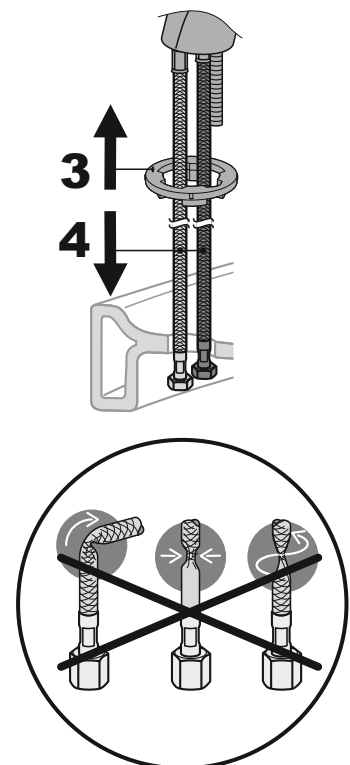

**3.**

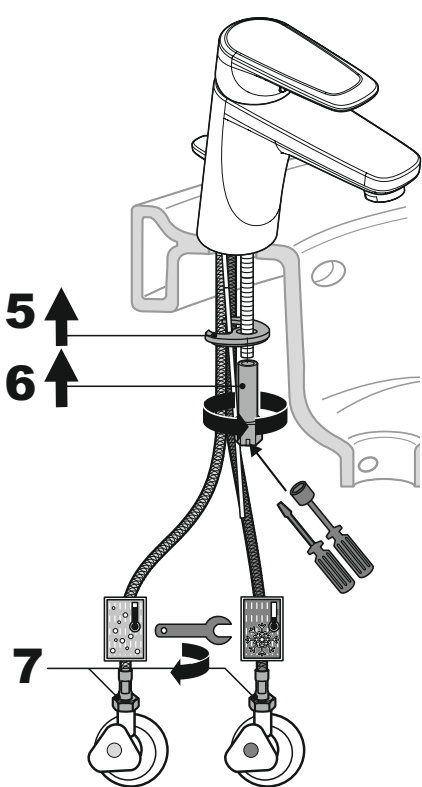

**4.**

